

PRODUCT SPECIFICATIONS

Elkay Stainless Steel 10-5/16" x 14" x 1-1/4" Bottom Grid. Overall dimensions are 10-5/16" x 14" x 1-1/4".

Made of Stainless Steel

Bottom grids are:

- Custom designed to protect and cover the bottom of your sink.
- Properly positioned opening for convenient access to drain or disposer.
- Built from solid stainless steel to resist corrosion and provide years of service.

Material:	Stainless Steel
Dimensions:	10-5/16" x 14" x 1-1/4"
Fits Bowl Size(s):	16-1/2" x 16-1/2"

Special Note: For bowls with rear center drain opening.

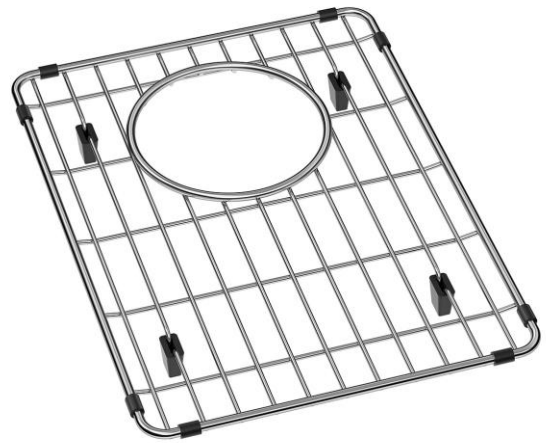

AMERICAN PRIDE. A LIFETIME TRADITION.

Like your family, the Elkay family has values and traditions that endure. For almost a century, Elkay has been a family-owned and operated company, providing thousands of jobs that support our families and communities.

[Clean and Care Manual \(PDF\)](#)

[Clean and Care Manual \(PDF\)](#)

[Warranty \(PDF\)](#)

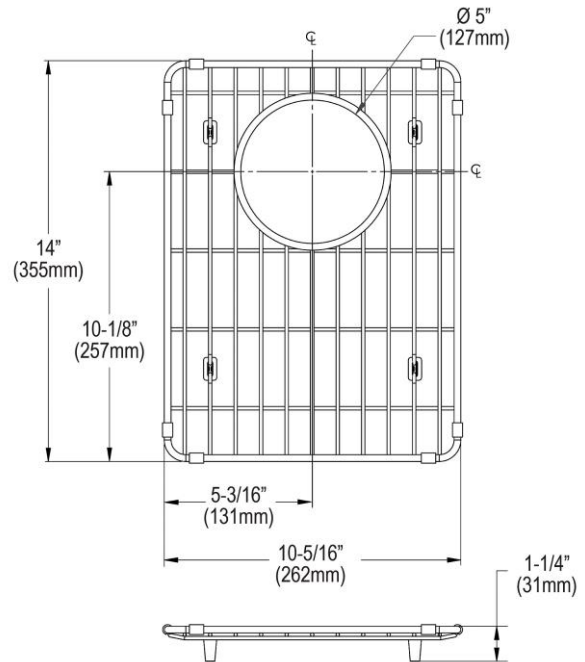

PART: _____ QTY: _____

PROJECT: _____

CONTACT: _____

DATE: _____

NOTES: _____









APPROVAL: _____

In keeping with our policy of continuing product improvement, Elkay reserves the right to change product specifications without notice. Please visit elkay.com for the most current version of Elkay product specification sheets. This specification describes an Elkay product with design, quality, and functional benefits to the user. When making a comparison of other producers' offerings, be certain these features are not overlooked.

Included Accessories

<p>item</p>	<p>included_accessories_description Spec Sheet (PDF)</p>	
-----------------------------	--	---

Optional Accessories

<p>item</p>	<p>bottom_grid_description Spec Sheet (PDF)</p>	
<p>item</p>	<p>colander_description Spec Sheet (PDF)</p>	
<p>item</p>	<p>cutting_board_description Spec Sheet (PDF)</p>	
<p>item</p>	<p>drain_description Spec Sheet (PDF)</p>	
<p>item</p>	<p>faucet_description Spec Sheet (PDF)</p>	
<p>item</p>	<p>rinsing_basket_description Spec Sheet (PDF)</p>	
<p>item</p>	<p>sinkmate_description Spec Sheet (PDF)</p>	
<p>item</p>	<p>optional_accessories_description Spec Sheet (PDF)</p>	

In keeping with our policy of continuing product improvement, Elkay reserves the right to change product specifications without notice. Please visit elkay.com for the most current version of Elkay product specification sheets. This specification describes an Elkay product with design, quality, and functional benefits to the user. When making a comparison of other producers' offerings, be certain these features are not overlooked.